

Questions? Call our customer service department at 1-877-706-3267, 8 a.m. - 5 p.m. Central Time, Monday - Friday.

UNIVERSAL WALL REMOTE

Model #51658

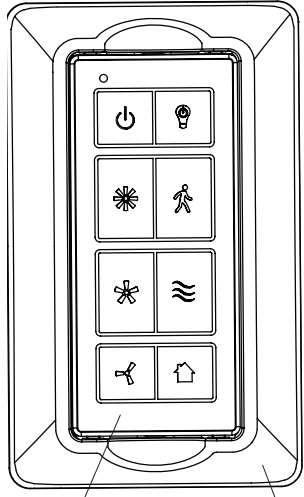

Remote Qty. 1
Wall Bracket Qty. 1

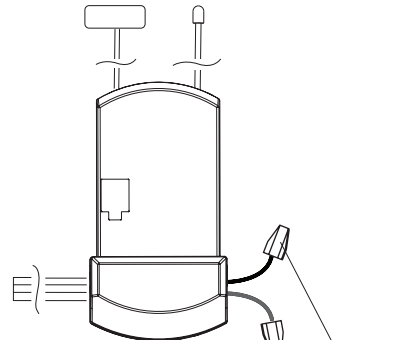

Receiver Qty. 1
Push-in Connector Qty. 2

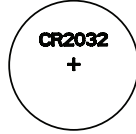

Battery Qty. 2



Wire Connector Qty. 3

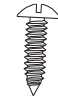

Mounting Screw Qty. 2



Owner's Manual Qty. 1

SAFETY INSTRUCTIONS

Read instructions completely before installing the remote.

WARNING: If the color of the household supply wires is different than what is referred to in the instructions below, a professional electrician should determine proper wiring.

CAUTION:

- Do not install in damp locations. For indoor use only.
- Do not use with fans that have integrated remote controls.
- Do not use with hugger-style fans.
- Be sure the outlet box is properly grounded or that a green or bare (ground) wire is present.
- This unit is intended to control a ceiling fan with electrical source of AC 110/120V, 60Hz.
- To reduce the risk of fire or electric shock, do NOT use a full-range dimmer switch to control the fan speed.
- CAN ICES-005 (B)/NMB-005 (B)

• This device complies with Industry Canada license-exempt RSS standard(s). Operation is subject to the following two conditions: (1) this device may not cause interference, and (2) this device must accept any interference, including interference that may cause undesired operation of the device.

• This device complies with Part 15 of the FCC Rules. Operation is subject to the following two conditions: (1) this device may not cause interference, and (2) this device must accept any interference received, including interference that may cause undesired operation. FCC ID: 2AQZU-18007.

This equipment has been tested and found to comply with the limits for a Class B digital device, pursuant to Part 15 of the FCC Rules. These limits are designed to provide reasonable protection against harmful interference in a residential installation. This equipment generates, uses and can radiate radio frequency energy and, if not installed and used in accordance with the instructions, may cause harmful interference to radio communications. However, there is no guarantee that interference will not occur in a particular installation. If this equipment does cause harmful interference to radio or television reception, which can be determined by turning the equipment off and on, the user is encouraged to try to correct the interference by one or more of the following measures:

- Reorient or relocate the receiving antenna.
- Increase the separation between the equipment and receiver.
- Connect the equipment into an outlet on a circuit different from that to which the receiver is connected.
- Consult the dealer or an experienced radio/TV technician for help. Any changes or modifications not expressly approved by the grantee of this device could void the user's authority to operate the equipment.

HKC-US, 3350 Players Club Pkwy. #225, Memphis, TN 38125, 1 (877) 706-3267

ASSEMBLY INSTRUCTIONS

1. Use existing pull chains on the desired fan to set fan speed to HIGH and to turn the light ON.

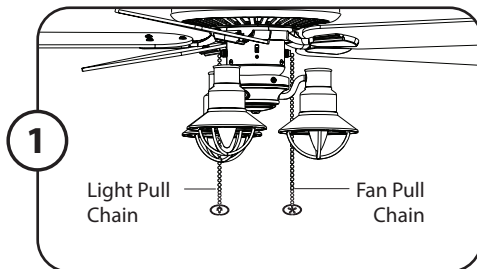

2. Turn off circuit breakers and wall switch to the fan. **DANGER:** Failure to disconnect power supply prior to installation may result in serious injury or death.

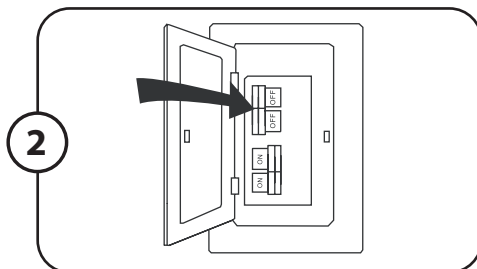

3. Lower the canopy of the previously assembled fan and insert receiver into the mounting bracket with antenna end first and the flat side facing the ceiling. **Note:** If installing this product with a new fan, insert the receiver in the mounting bracket before wiring the fan; wire the fan according to these instructions, then continue fan assembly as directed in the fan's instruction manual.

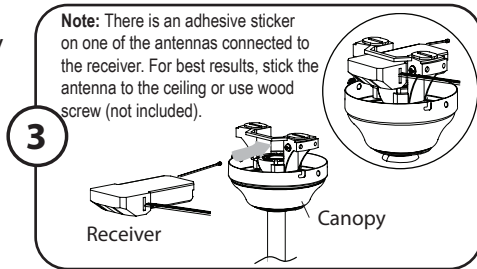

4. Disconnect existing wire connections (if applicable), then secure all wire connections with wire connectors according to diagram and these steps:

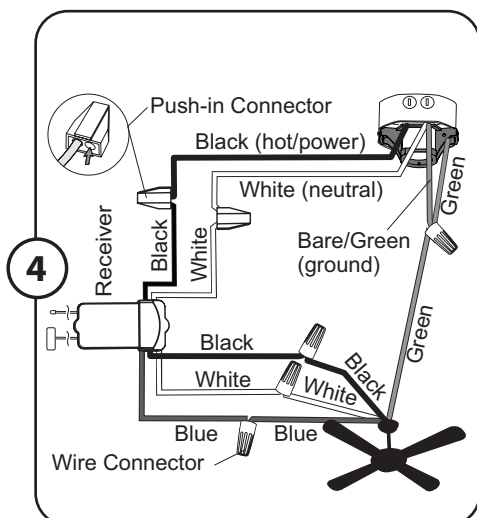

- Connect the Green wires from the downrod and the mounting bracket to the Bare/Green (ground) supply wire.
- Connect the Blue wire (FOR LIGHT) from the receiver to the Blue fan wire.
- Connect the Black wire (TO MOTOR L) from the receiver to the Black fan wire.
- Connect the White wire (TO MOTOR N) from the receiver to the White fan wire.
- Push the Black (Hot/Power) supply wire into the empty wire hole in push-in wire connector preassembled to the Black wire (AC IN L).
- Push the White (neutral) supply wire into the empty wire hole in push-in wire connector preassembled to the White wire (AC IN N).

5. Wrap electrical tape (not included) around each wire connector down to the wire. Then, push wire connections into the outlet box. Place the White wire connections on the opposite side of the outlet box from the Black and Blue wire connections.

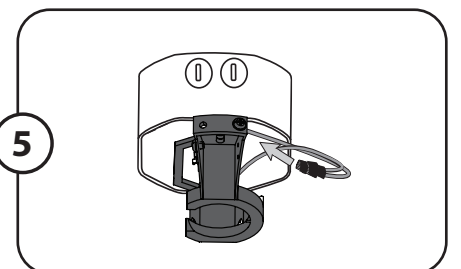

6. Reinstall the canopy.

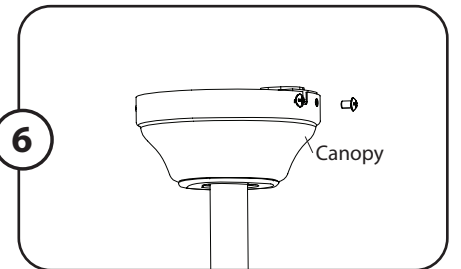

7. Turn on power supply and wall switch to the fan.

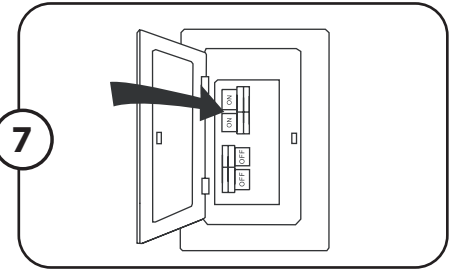

8. Remove the battery door from the back of the remote using a flat-head screwdriver (not included). Insert the two CR2032 batteries into the remote; ensure the positive pole of the batteries face up (as pictured) and then replace the battery door. Press the HIGH SPEED button to ensure the LED indicator illuminates and the fan turns on.

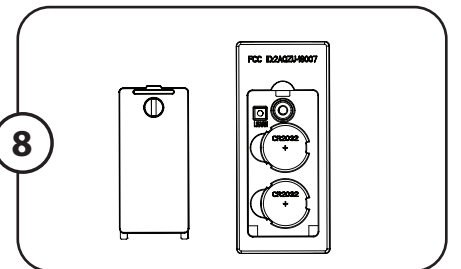

9. If desired, the wall bracket can be attached to a wall using the mounting screws.

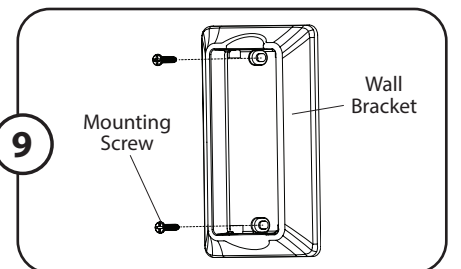

OPERATING INSTRUCTIONS

1. To operate the fan using the remote, make sure fan pull chain is on high and light is turned on. Then press and release the following buttons:

Fan Off - Turns the power to fan off.

Light On/Off - Turns the light on and off. Press and hold to dim or brighten lights (for dimmable bulbs only).

High Speed - Turns on fan at high speed.

Light Delay - Light stays on for 60 seconds to allow for safe exit from room. **Note:** Tap Light Delay once to activate. Fan light blinks once to confirm Light Delay is active. Press any button to cancel.

Medium Speed - Turns on fan at medium speed.

Variable Breeze - Simulates a breeze in nature. Press and hold button to activate. Press any fan speed button to cancel.

Low Speed - Turns on fan at low speed.

Home Shield™ - Simulates occupancy while away from home. Fan remains off and the light randomly turns on for a minimum of five times and a maximum of 20 minutes. The light remains off for 60 minutes between events. Press and hold button to activate. Light will blink twice to confirm Home Shield is active. Press any button to cancel.

LED indicator should illuminate when any remote button is pressed. If not, replace the DC3V, CR2032 batteries.

LEARN button - Syncs remote to receiver (see TROUBLESHOOTING for instructions). **Note:** To access LEARN button, remove battery door from back of the remote using a flat-head screwdriver.

2. To control the fan via WiFi remote, download the Fansio® app to your smartphone. Load the app and follow the in-app instructions to sync with the remote. You will need your personal WiFi network name and password.

Note: The remote receiver is compatible with 2.4 GHz only and will not work with 5.0 GHz routers.

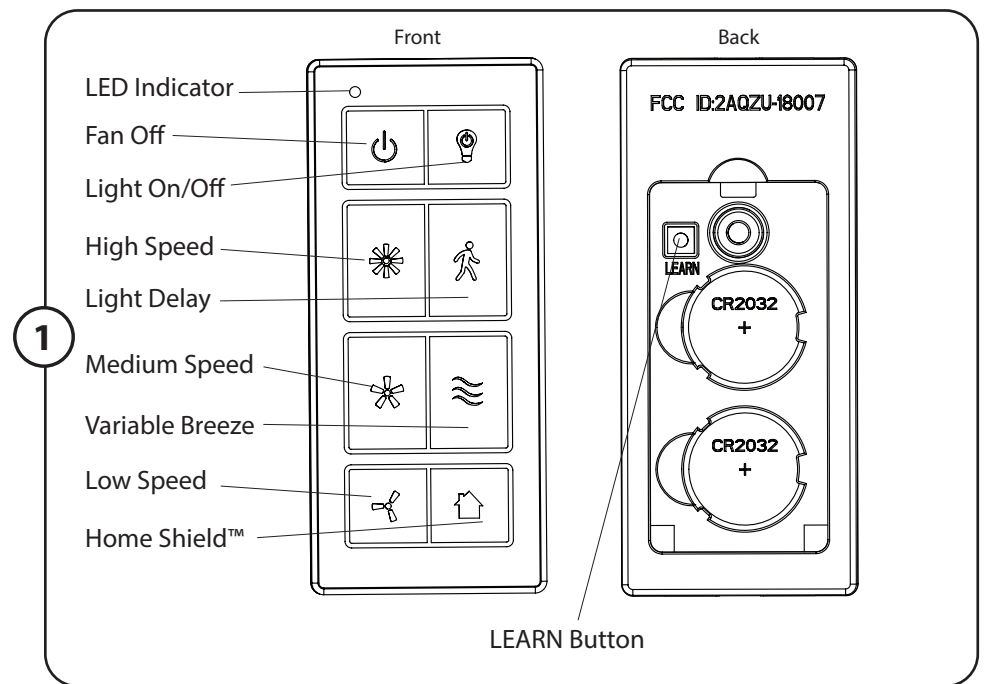

TROUBLESHOOTING

If you have difficulty operating your remote, or have difficulty with installation, please contact Customer Service : 1-877-706-3267, 8 a.m. - 5 p.m. Central Time.

WARNING: Ensure the power is turned off to the fan/remote before performing any maintenance.

LED indicator on the remote illuminates, but the remote won't control the fan. The remote may need to be re-synced.

The remote is synced to the receiver at the factory. Occasionally, power surges can cause the remote to become un-synced. Whenever necessary, follow the syncing instructions below.

SYNCING INSTRUCTIONS: Switch the power to the fan off and back on again. Within 30 seconds, press and hold the HIGH SPEED and LOW SPEED buttons (or the "LEARN" button, located in the battery compartment) for 5 seconds. Fan will turn on at low speed and light off. This confirms the syncing process is successful.

Power surge may have cleared memory and remote and re-syncing did not resolve the issue.

FACTORY RESET OF REMOTE: Turn the power to the fan off for 3 seconds, then turn the power back on for 3 seconds. Repeat this 5 times. The light will blink to confirm the reset was successful.

The LED indicator on the remote does not illuminate.

The batteries most likely need to be replaced or are not oriented correctly in the battery compartment. If batteries are depleted rapidly, ensure one of buttons is not stuck in the down position.

The LED indicator stays on.

Ensure one of buttons is not stuck in the down position.

Remote controls more than one fan.

Turn off the power to the fans you don't want synced. Follow the syncing instructions listed above. Then, turn on the power to the other fans.

Dimming feature does not function.

Ensure the bulbs are incandescent or other dimmable bulbs.

Fan will not run at high speed. If your fan has manual pull chains to operate the fan speed, be sure the pull chain is manually set to HIGH SPEED. If your pull chain is set to LOW or MEDIUM SPEED, the remote will not override the manual pull chain setting.

Light will not turn on. If your fan has manual pull chains, be sure the light pull chain is set to ON. The remote will not override the manual pull chain setting.

1-YEAR LIMITED WARRANTY

To obtain service, please contact Customer Service: 1-877-706-3267, 8 a.m. - 5 p.m. Central Time, Monday - Friday.

The manufacturer warrants all of its lighting fixtures against defects in materials and workmanship for one (1) year from the date of purchase. If within this period the product is found to be defective, take a copy of the bill of sale as a proof of purchase and the product in its original carton to the place of purchase. The manufacturer will, at its option, repair, replace or refund the purchase price to the consumer. All costs of installation and removal of the fixture is the responsibility of the consumer. This warranty does not cover fixtures becoming defective due to misuse, accidental damage or improper handling and/or installation and specifically excludes liability for direct, incidental or consequential damages. As some states do not allow exclusions of limitations on an implied warranty, the above exclusion and limitation may not apply. This warranty gives you specific rights and you may also have other rights which may vary from state to state.